





Firmenname	
Anschrift	
Ort	
Tel.	
Fax	
E-Mail	
Kontaktperson Technik	
Kontaktperson Einkauf	
Angebots-Abgabetermin	
Wunsch-Liefertermin	
Branche	<input type="checkbox"/>  <input type="checkbox"/>  <input type="checkbox"/>  <input type="checkbox"/>  <input type="checkbox"/>  <input type="checkbox"/> Andere _____

1. Packstückbeschreibung

Welches Produkt ?

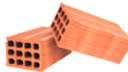

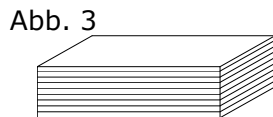
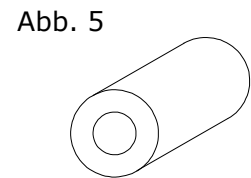
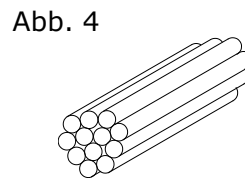
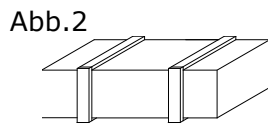
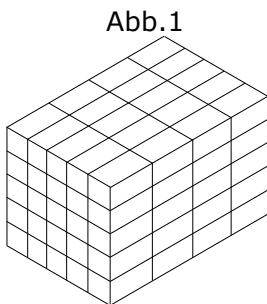
2. Paketumreifung

2.1 Packstückdaten

Paket (Karton / Wfs) Förderrichtung →

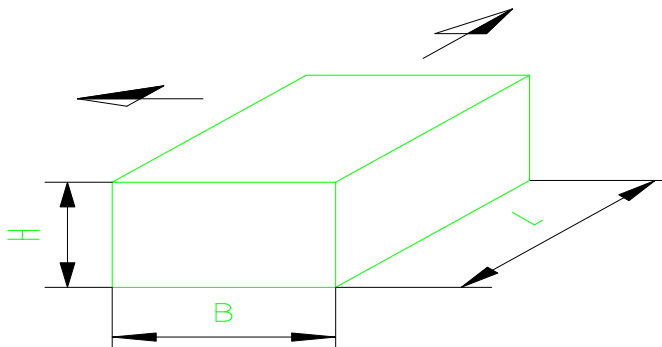

L = max min [mm]

B = max min [mm]

H = max min [mm]

Gewicht = min max [kg]

2.2 Sonderpackstücke skizzieren, vermaßen und beschreiben



3. Palettenumreifung

3.1 Palettentyp

Euro-Pool-Palette
 1.200 x 800 x 145 mm

Industrie-Palette
 1.200 x 1.000 x 145 mm

Andere z.B. Inka (Wichtig bei offenem Drehteller)

L	B	H	
x	x		mm
x	x		mm
x	x		mm

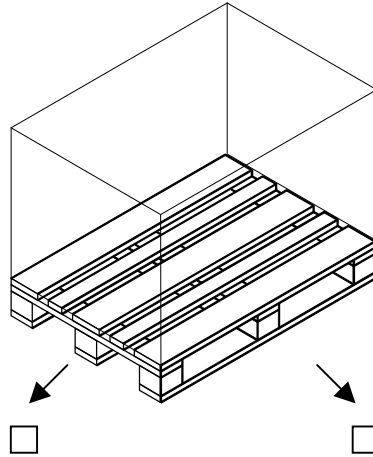

Palettenform A

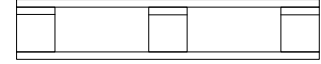

Palettenform B



Palettenform C



Wie ist die Ware auf der Palette?

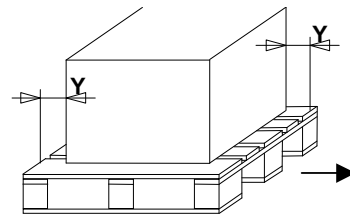
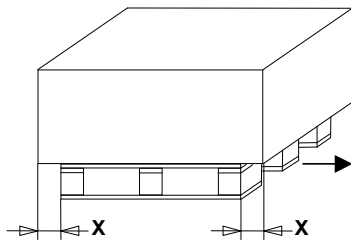

Packgut: steht über ist bündig ist kleiner instabil durcheinander

